



History-Based Value Report

History events affecting this vehicle's value



1

1-Owner Vehicle



Regular Oil Changes



Minor Damage

\$20,760 Retail Value



Vehicle History Report™

2019 FORD FUSION SE

VIN: 3FA6P0LU5KR200885
SEDAN 4 DR
2.0L I4 F DOHC 16V
HYBRID
FRONT WHEEL DRIVE
Original Window Sticker

Accident reported: minor damage

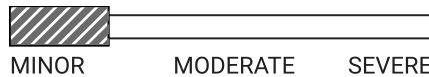

Regular oil changes



CARFAX 1-Owner vehicle



Corporate fleet vehicle



39,672 Last reported odometer reading

This CARFAX Vehicle History Report is based only on information supplied to CARFAX and available as of 1/26/23 at 10:11:42 PM (CST). Other information about this vehicle, including problems, may not have been reported to CARFAX. Use this report as one important tool, along with a vehicle inspection and test drive, to make a better decision about your next used car.



Ownership History

The number of owners is estimated

Owner 1

Year purchased

2019

Type of owner



Corporate fleet

Estimated length of ownership

6 months





Owned in the following states/provinces	California
Estimated miles driven per year	---
Last reported odometer reading	39,672

 Title History CARFAX guarantees the information in this section	Owner 1
Damage Brands Salvage Junk Rebuilt Fire Flood Hail Lemon	<input checked="" type="checkbox"/> Guaranteed No Problem
Odometer Brands Not Actual Mileage Exceeds Mechanical Limits	<input checked="" type="checkbox"/> Guaranteed No Problem
 GUARANTEED - None of these major title problems were reported by a state Department of Motor Vehicles (DMV). If you find that any of these title problems were reported by a DMV and not included in this report, CARFAX will buy this vehicle back. View Terms View Certificate	

 Additional History Not all accidents / issues are reported to CARFAX	Owner 1
Total Loss No total loss reported to CARFAX.	<input checked="" type="checkbox"/> No Issues Reported
Structural Damage CARFAX recommends that you have this vehicle inspected by a collision repair specialist.	<input checked="" type="checkbox"/> No Issues Reported
Airbag Deployment No airbag deployment reported to CARFAX.	<input checked="" type="checkbox"/> No Issues Reported
Odometer Check No indication of an odometer rollback.	<input checked="" type="checkbox"/> No Issues Indicated
Accident / Damage Accident reported: 08/30/2019.	Minor Damage
Manufacturer Recall A current list of recalls is available at Ford Motor Company.	<input checked="" type="checkbox"/> No Recalls Reported
Basic Warranty Original warranty estimated to have expired.	Warranty Expired

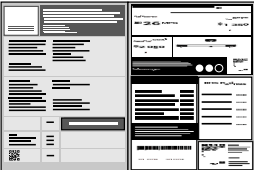



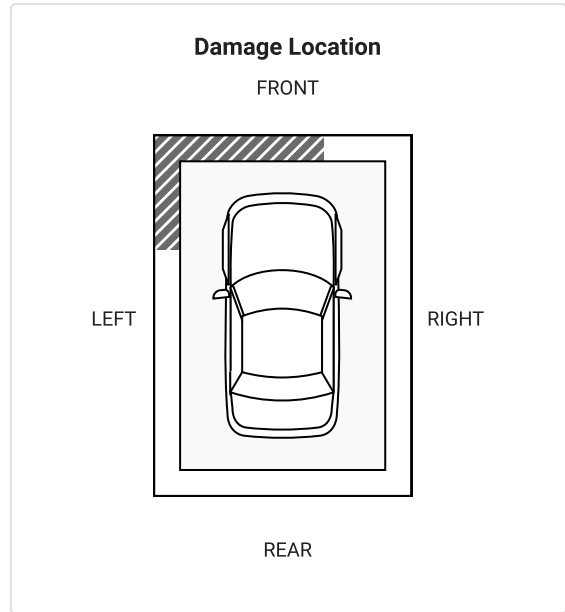
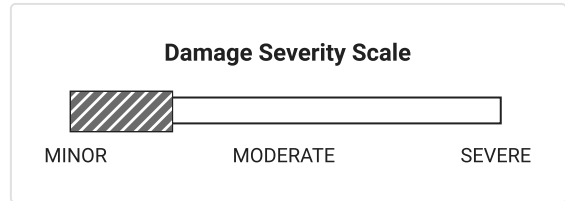

 Detailed History	
 Owner 1 Purchased: 2019	Corporate Fleet Vehicle



Date	Mileage	Source	Comments
03/08/2019		Ford Motor Company	Vehicle manufactured and shipped to original dealer  Original Window Sticker
03/29/2019		Encinitas Ford Encinitas, CA 760-753-6286 ★ 4.5 / 5.0 83 Verified Reviews ♥ 83 Customer Favorites	Vehicle offered for sale
04/01/2019	2	Encinitas Ford Encinitas, CA 760-753-6286 ★ 4.5 / 5.0 83 Verified Reviews ♥ 83 Customer Favorites	 Vehicle serviced - Pre-delivery inspection completed - Tire condition and pressure checked
04/30/2019		Encinitas Ford Encinitas, CA 760-753-6286 ★ 4.5 / 5.0 83 Verified Reviews ♥ 83 Customer Favorites	Vehicle sold
04/30/2019	12	California Motor Vehicle Dept. Encinitas, CA	Odometer reading reported
05/14/2019		California Motor Vehicle Dept. Encinitas, CA	Title issued or updated - First owner reported - Loan or lien reported - Titled or registered as corporate fleet vehicle
08/30/2019		Damage Report	 Accident reported: minor damage - Damage to left front - Damage to front - Damage to undercarriage - Vehicle towed



Minor damage is usually cosmetic, including dents or scratches to the vehicle body.

11/26/2019	5,936	Encinitas Ford Encinitas, CA 760-753-6286	Vehicle sold
		★ 4.5 / 5.0 83 Verified Reviews ♥ 83 Customer Favorites	
11/27/2019		Encinitas Ford Encinitas, CA 760-753-6286	Vehicle offered for sale
		★ 4.5 / 5.0 83 Verified Reviews ♥ 83 Customer Favorites	
11/29/2019		Encinitas Ford Encinitas, CA 760-753-6286	Vehicle sold
		★ 4.5 / 5.0 83 Verified Reviews ♥ 83 Customer Favorites	

03/12/2020	9,979	Encinitas Ford Encinitas, CA 760-753-6286 ★ 4.5 / 5.0 83 Verified Reviews ♥ 83 Customer Favorites	 Vehicle serviced - Maintenance inspection completed - Tire condition and pressure checked - Brakes checked - Oil and filter changed - Tires rotated
06/17/2020	11,506	Encinitas Ford Encinitas, CA 760-753-6286 ★ 4.5 / 5.0 83 Verified Reviews ♥ 83 Customer Favorites	 Vehicle serviced - Engine/powertrain computer/module checked - Tire condition and pressure checked - Camshaft position sensor replaced - Oil and filter changed
12/01/2020	14,233	Encinitas Ford Encinitas, CA 760-753-6286 ★ 4.5 / 5.0 83 Verified Reviews ♥ 83 Customer Favorites	 Vehicle serviced - Vehicle washed/detailed
02/23/2021	15,918	Encinitas Ford Encinitas, CA 760-753-6286 ★ 4.5 / 5.0 83 Verified Reviews ♥ 83 Customer Favorites	 Vehicle serviced - Maintenance inspection completed - Tire condition and pressure checked - Brakes checked - Oil and filter changed - Tires rotated
03/26/2021	16,310	Encinitas Ford Encinitas, CA 760-753-6286 ★ 4.5 / 5.0 83 Verified Reviews ♥ 83 Customer Favorites	 Vehicle serviced - Tire condition and pressure checked
11/29/2021	25,874	Encinitas Ford Encinitas, CA 760-753-6286 ★ 4.5 / 5.0 83 Verified Reviews ♥ 83 Customer Favorites	 Vehicle serviced - Maintenance inspection completed - Cabin air filter replaced/cleaned - Tire condition and pressure checked - Brakes checked - Oil and filter changed - Tires rotated
02/08/2022	28,134	Encinitas Ford Encinitas, CA 760-753-6286 ★ 4.5 / 5.0 83 Verified Reviews ♥ 83 Customer Favorites	 Vehicle serviced - Vehicle washed/detailed

04/01/2022	30,364	Encinitas Ford Encinitas, CA 760-753-6286	 Vehicle serviced - Tire condition and pressure checked
		★ 4.5 / 5.0 83 Verified Reviews ♥ 83 Customer Favorites	
08/26/2022	35,372	Encinitas Ford Encinitas, CA 760-753-6286	 Vehicle serviced - Maintenance inspection completed - Tire condition and pressure checked - Brakes checked - Oil and filter changed - Tires rotated
		★ 4.5 / 5.0 83 Verified Reviews ♥ 83 Customer Favorites	
10/25/2022	38,036	Encinitas Ford Encinitas, CA 760-753-6286	 Vehicle serviced - Tire condition and pressure checked - Drivability/performance checked
		★ 4.5 / 5.0 83 Verified Reviews ♥ 83 Customer Favorites	
01/10/2023	39,672	Encinitas Ford Encinitas, CA 760-753-6286	Vehicle offered for sale
		★ 4.5 / 5.0 83 Verified Reviews ♥ 83 Customer Favorites	



This vehicle's oil change history, as reported to CARFAX, follows the manufacturer's recommendation. Track your service history for free at [carfax.com/service](https://www.carfax.com/service).

Have Questions? Please visit our Help Center at www.carfax.com.



Glossary

Accident Indicator

CARFAX receives information about accidents in all 50 states, the District of Columbia and Canada.

Not every accident is reported to CARFAX. As details about the accident become available, those additional details are added to the CARFAX Vehicle History Report. CARFAX recommends that you have this vehicle inspected by a qualified mechanic.

- According to the National Safety Council, Injury Facts, 2021 edition, 5% of the 276 million registered vehicles in the U.S. were involved in an accident in 2019. Over 77% of these were considered minor or moderate.
- This CARFAX Vehicle History Report is based only on information supplied to CARFAX and available as of 1/26/23 at 10:11:42 PM (CST). Other information about this vehicle, including problems, may not have been reported to CARFAX. Use this report as one important tool, along with a vehicle inspection and test drive, to make a better decision about your next used car.

CARFAX Well Maintained - Regular Oil Changes

CARFAX identifies a "Well Maintained - Regular Oil Change" vehicle as having a regular oil change history when all its recommended oil changes, based on the vehicle's maintenance schedule, have been reported to CARFAX. CARFAX uses the manufacturer's schedule and assumes normal driving conditions. When an oil change schedule is not available, CARFAX may analyze reported service events to determine what is typical for the same make and model vehicle. Dealers and service shops may publish different recommended service schedules.

Damage Severity

Damage events result in one of the following severity levels:

- **Minor:** Generally, minor damage is cosmetic (including dents or scratches), may only require reconditioning, and typically does not compromise a vehicle's operation and/or safety.
- **Moderate:** Moderate damage may affect multiple components of the vehicle and may impair the vehicle's operation and/or safety.
- **Severe:** Severe damage usually affects multiple components of the vehicle and is likely to compromise the vehicle's operation and/or safety.

CARFAX recommends getting a pre-purchase inspection at a certified collision repair facility.

First Owner

When the first owner(s) obtains a title from a Department of Motor Vehicles as proof of ownership.

Fleet Vehicle

Vehicle was registered or sold to a company that manages vehicle fleets.

Ford or Lincoln Mercury Recall

The Ford Motor Company provides CARFAX with Field Service Action and recall information regarding safety, compliance and emissions programs announced since 2000 for a specific vehicle. For complete information regarding programs or concerns about this vehicle, please contact a local Ford or Lincoln Mercury Dealer.

Ownership History

CARFAX defines an owner as an individual or business that possesses and uses a vehicle. Not all title transactions represent changes in ownership. To provide estimated number of owners, CARFAX proprietary technology analyzes all the events in a vehicle history. Estimated ownership is available for vehicles manufactured after 1991 and titled solely in the US including Puerto Rico. Dealers sometimes opt to take ownership of a vehicle and are required to in the following states: Maine, Massachusetts, New Jersey, Ohio, Oklahoma, Pennsylvania and South Dakota. Please consider this as you review a vehicle's estimated ownership history.

Title Issued

A state issues a title to provide a vehicle owner with proof of ownership. Each title has a unique number. Each title or registration record on a CARFAX report does not necessarily indicate a change in ownership. In Canada, a registration and bill of sale are used as proof of ownership.

Follow Us:



[facebook.com/CARFAX](https://www.facebook.com/CARFAX)



[@CARFAXinc](https://twitter.com/CARFAXinc)



[About CARFAX](#)

CARFAX DEPENDS ON ITS SOURCES FOR THE ACCURACY AND RELIABILITY OF ITS INFORMATION. THEREFORE, NO RESPONSIBILITY IS ASSUMED BY CARFAX OR ITS AGENTS FOR ERRORS OR OMISSIONS IN THIS REPORT. CARFAX FURTHER EXPRESSLY DISCLAIMS ALL WARRANTIES, EXPRESS OR IMPLIED, INCLUDING ANY IMPLIED WARRANTIES OF MERCHANTABILITY OR FITNESS FOR A PARTICULAR PURPOSE.

© 2023 CARFAX, Inc., part of S&P Global. All rights reserved.

1/26/23 10:11:42 PM (CST)



Warranty Check™

CARFAX has estimated the remaining original manufacturer warranty coverage based on information reported to us on this **2019 FORD FUSION SE (3FA6P0LU5KR200885)**.

Please confirm remaining factory warranty and extended warranty options with your dealer or vehicle manufacturer.

2019 FORD FUSION SE

VIN: 3FA6P0LU5KR200885

Estimated start date of warranty: 05/14/2019

Last CARFAX reading reported on 01/10/2023: 39,672 miles

Today's Date: 01/26/2023

Enter the current mileage and click 'Recalculate Warranty' to update the remaining warranty coverage.

Enter current mileage:

Recalculate Warranty

Type of Coverage	Original Warranty	Estimated Remaining Coverage
Basic	36 months or 36,000 miles	Coverage Expired
Drivetrain	60 months or 60,000 miles	16 months or 20,328 miles
Emissions	96 months or 80,000 miles	52 months or 40,328 miles
Corrosion	60 months or unlimited mileage	16 months or unlimited mileage
Transferable	No cost, unlimited owners covered.	Same
Roadside	No data reported to CARFAX	
Safety belt & inflatable restraint	60 months or 60,000 miles	16 months or 20,328 miles
Specific Components	No data reported to CARFAX	
Notes	Emissions: Manufacturer covers emissions components under basic warranty. Emissions coverage may vary by state. Refer to owners manual for specific details. Transferable: No cost, unlimited owners covered. Roadside Assistance: Administered by Ford Roadside Assistance. Safety Restraint: Safety belt and inflatable restraint system covered for 5/60,000. Safety belt coverage 10/Unlimited for new vehicles sold in the state of Kansas. Specific Components: Tire defect coverage is prorated during the New Vehicle Limited Warranty period. Maintenance: Alignment and wheel balance covered 1/12,000. Notes: N/A.	

i CARFAX Warranty Check provides an **estimate** of this vehicle's remaining warranty coverage. It does not take into account some vehicle history events such as some title brands that may void the original manufacturer warranty or ownership transfers that may decrease warranty coverage. This warranty information is only valid for vehicles manufactured for the United States. Complete warranty coverage information is available for this vehicle at the FORD website.



CARFAX Buyback Guarantee

CARFAX Buyback Coverage:

01/26/2023 - 01/26/2024

CARFAX Vehicle Description:

2019 FORD FUSION SE

VIN: 3FA6P0LU5KR200885	Body Style: Sedan 4 DR
Driveline: Front wheel drive	Engine: 2.0L I4 F DOHC 16V

CARFAX will buy this vehicle back if

you find that any of these severe problems were reported by a Department of Motor Vehicles and were not included in this report.



Severe Damage:

Salvage/Junk
Rebuilt/Reconstructed
Dismantled
Fire/Flood/Hail



Odometer Problems:

Exceeds Mechanical
Limits
Not Actual Mileage



Lemon history:

Manufacturer Buyback

Terms and Conditions Apply

[View Terms and Conditions for CARFAX Buyback Guarantee coverage](#)